

Diritti riservati All rights reserved

1

2

3

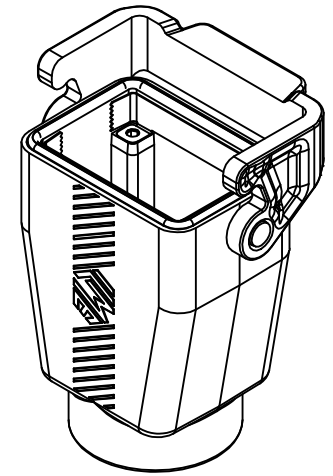
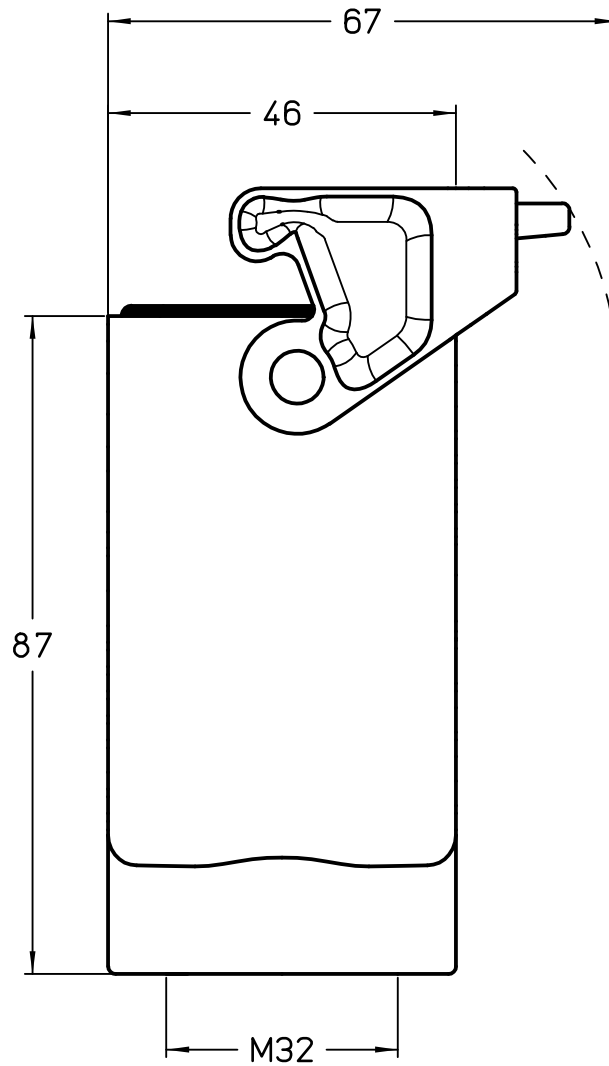
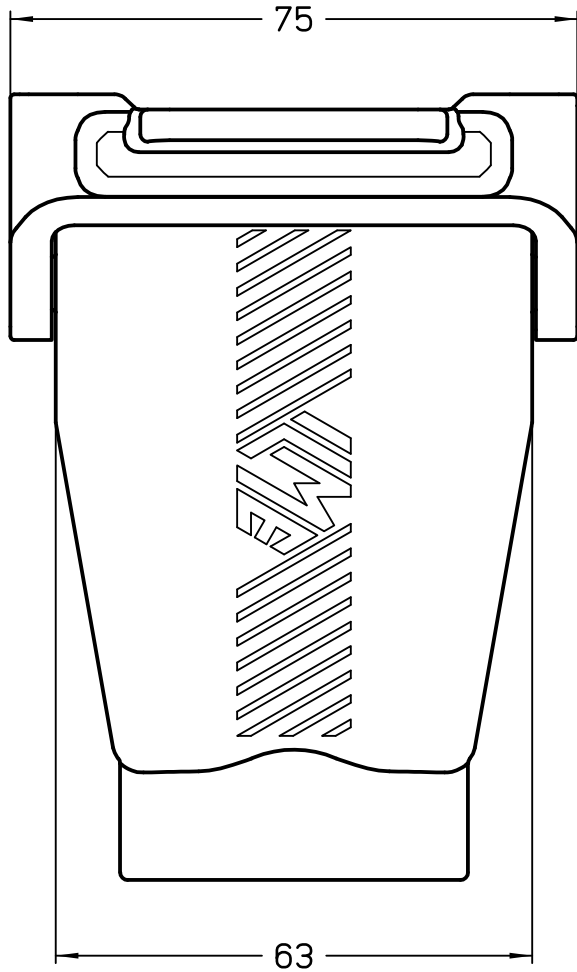

Dimensions
in mm

Simplified representation with dimensions without tolerance

Original Size A4

TMAV06LG32B

Date 06/11/23

Insulating hood, size "44.27", M32 top entry,

Sign. G. Renna

with 1 lever, with integrated PE jumpers - T-Type

Scale
1:1



1

2

3