

Diritti riservati

All rights reserved

1

2

3

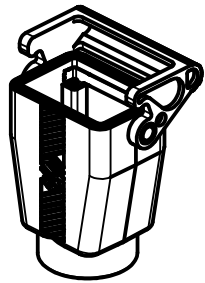
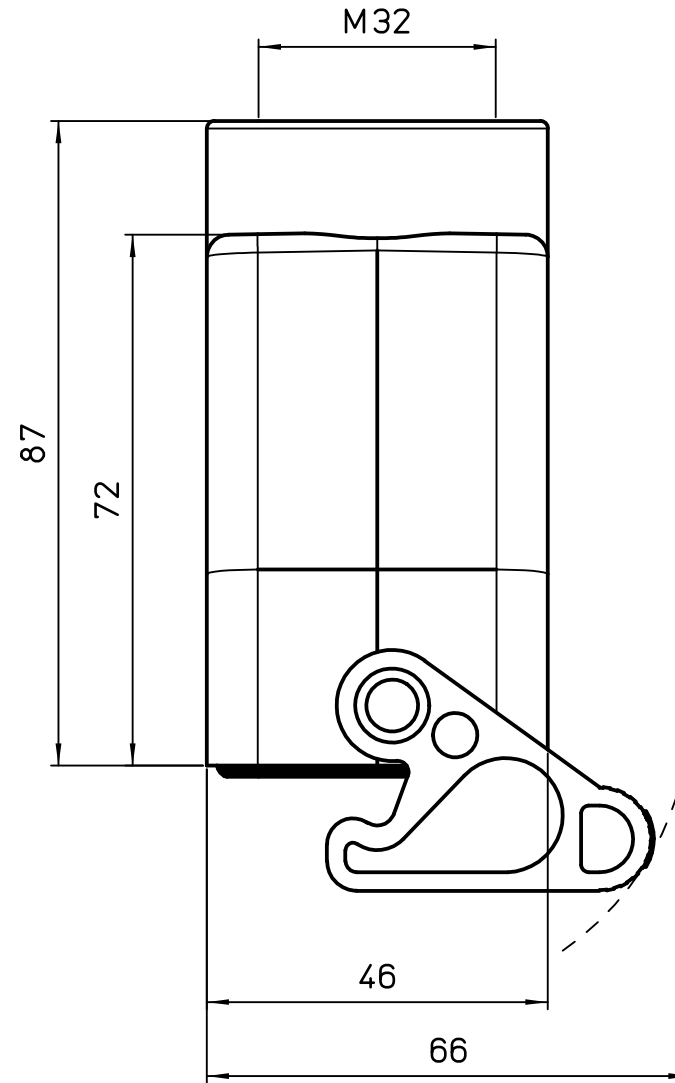
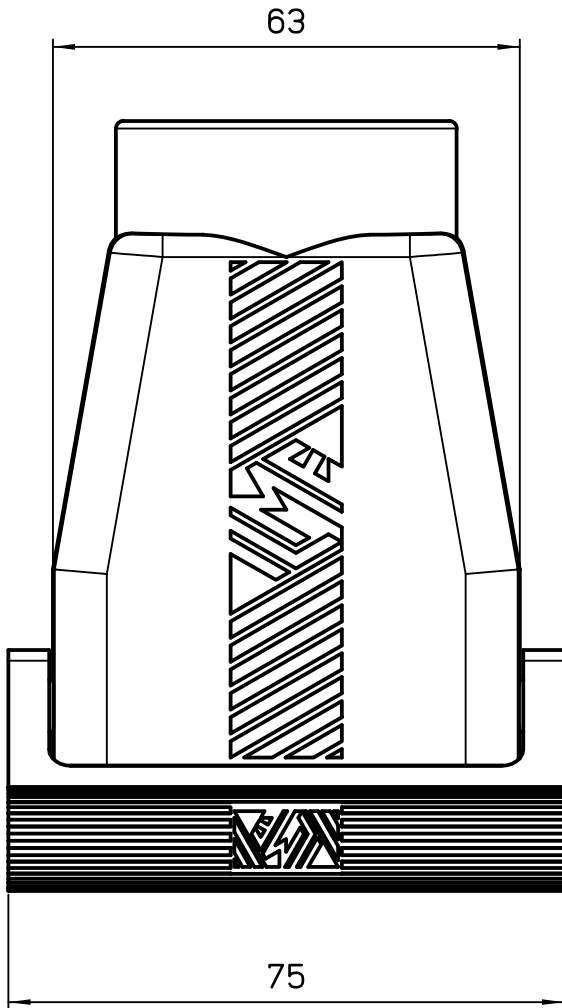

REV.	DATE	SIGNATURE		
 Dimensione in mm			Simplified representation with dimensions without tolerance	
Original Size A4			TAVH06LG32B Insulating hood top entry M32 1 lever with P.E. jumper - HYGIENIC	Scale 1:1
Date 23/06/20				
Sign. B. Pitasi				



1

2

3