

1

2

3

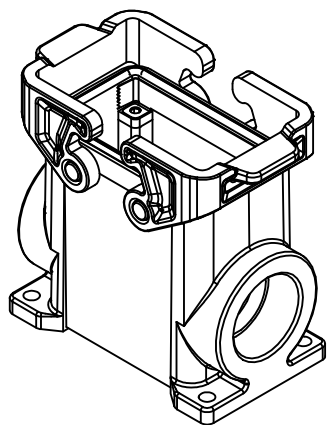
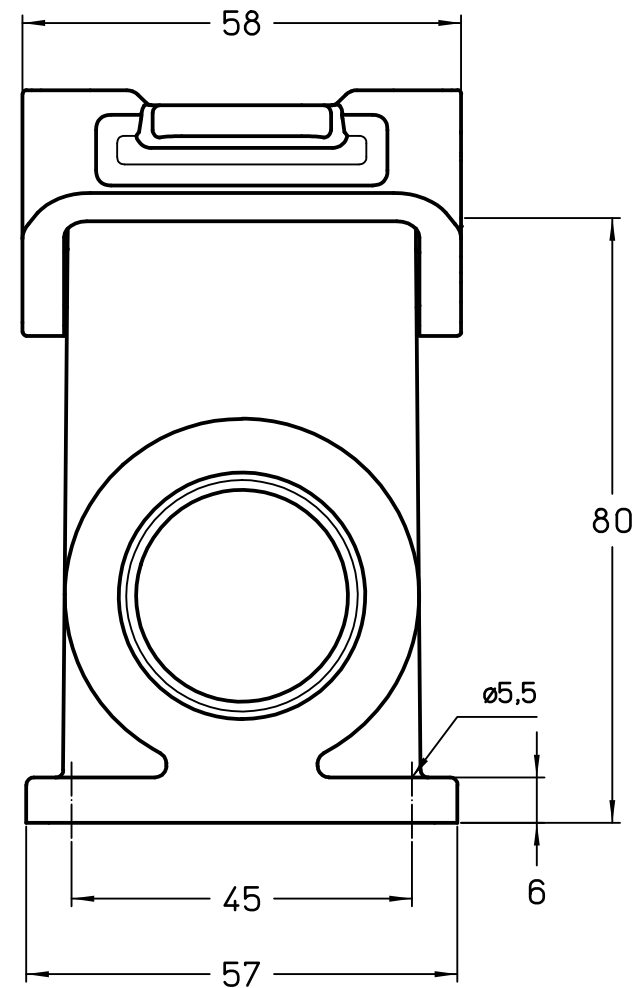
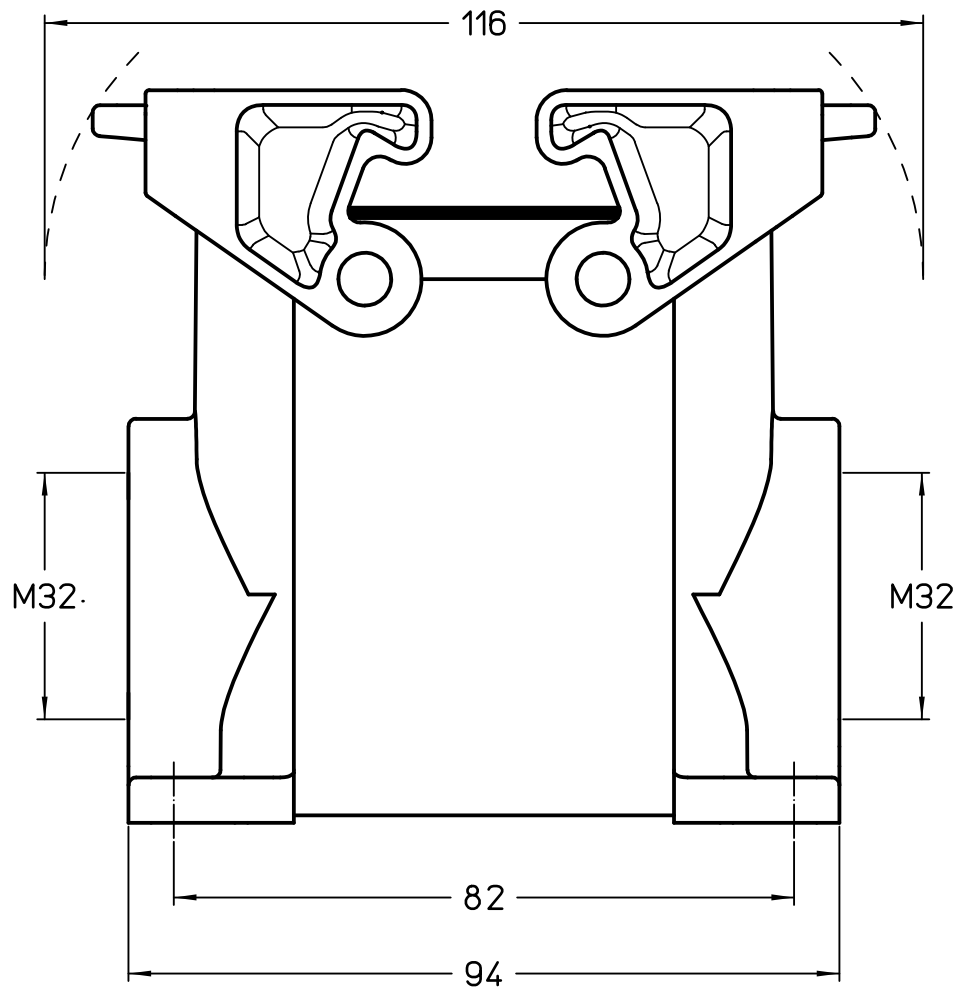

Dimensions in mm

Simplified representation with dimensions without tolerance

Original Size A4

TAPC10.232B

Date 14/02/22

Insulating surface mounting housing, size "57.27", 2x M32 side entries,

Sign. G. Renna

with 2 levers, with integrated PE jumpers - HYGIENIC-COLD

Scale 1:1



1

2

3