

Part number

MXA 02 V32



Hood, MIXO TWO series, with 2 pegs, M32 top cable entry, 2 modules, with PE connection terminal and contact

Product description		Material properties	
Product type	Hood	Main material	Zinc die-cast
Series	MIXO TWO	Other materials	Lever: Thermoplastic material and stainless steel core
Closing type	With 2 pegs	Colour	RAL 7040 grey
Size	2 modules	RoHs conformity	Compliant
Cable entry	Top cable entry M32	China RoHs - EFUP	E
Specification	With PE connection terminal and contact	REACH SVHC substances	No
Technical data		General ordering information	
IP degree of protection	IP65	EAN13 code	8015747102049
Further technical details		eCl@ss 8.1	27440202
Mating cycles	≥ 500	ETIM 7.0	EC000437
Weight	190,50 g	Packaging Information	
Operating temperature range (min, max)	-40°C...+125°C	Packaging length	180,00 mm
Tightening torque for PE connection	1,2 Nm	Packaging height	120,00 mm
		Packaging width	155,00 mm
		Packaging weight	2,06 kg
		Packaging volume	3,35 dm ³
		Packaging description	Carton box
		Packaging quantity	10 Pcs
		Packaging EAN code	8015747145237
		Sub-packaging weight	0,21 kg
		Sub-packaging description	Plastic bag
		Sub-packaging quantity	1 Pcs
		Sub-packaging EAN barcode	8015747171861

Part number

MXA 02 V32



Catalogue drawings

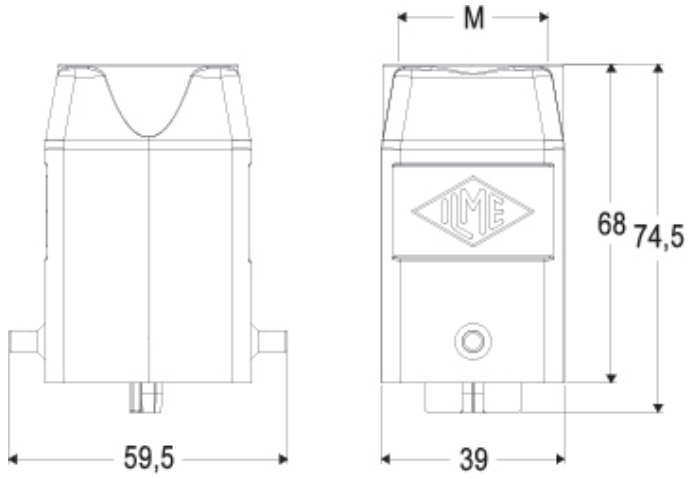

Notes

Dimensions shown in mm are not binding and may be changed without notice.
