

Part number

MMAO 16.40



Hood, 830V series, with 4 pegs, M40 side cable entry, size "104.27", high construction

Product description

Product type	Hood
Series	830V
Closing type	With 4 pegs
Size	Size 104.27
Cable entry	Side cable entry M40
Specification	High construction

Technical data

IP degree of protection IP65 / IP66 / IP69

Further technical details

Weight	226,00 g
Operating temperature range (min, max)	-40°C...+125°C

Material properties

Colour	RAL 7040 grey
RoHs conformity	Compliant
China RoHs - EFUP	E
REACH SVHC substances	No

Approvals / Standards

Certifications	DNV, BV
UL	ECBT2
cUL	ECBT8

General ordering information

EAN13 code 8015747057202

Packaging Information

Sub-packaging weight	1,13 kg
Sub-packaging description	Plastic packaging
Sub-packaging quantity	5 Pcs
Sub-packaging EAN barcode	8015747100274

Part number

MMAO 16.40



Catalogue drawings

**CMO [CMAO] CMV (CMAV) - MMO [MMAO]
MMV (MMAV)**

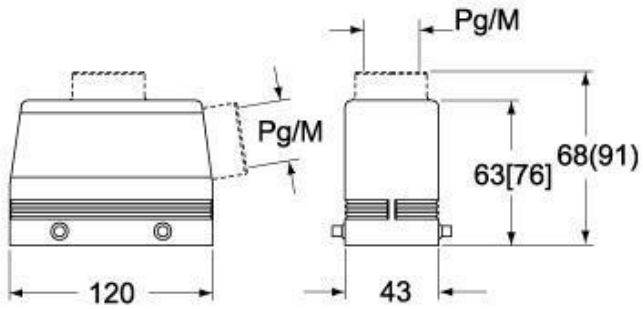

CMV G (CMAV G) - MMV G (MMAV G) - [MMFV G]



Notes

Dimensions shown in mm are not binding and may be changed without notice.