

Part number

# MHV 16 X25

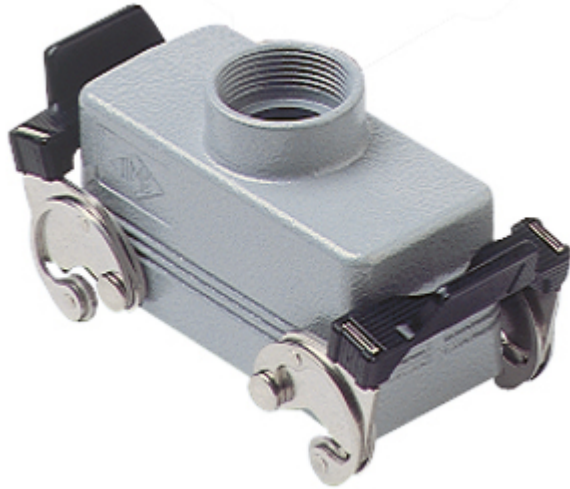

Hood, C-TYPE series, with 2 levers, M25 top cable entry, size "77.27", without gasket

Product description		Material properties	
<b>Product type</b>	Hood	<b>Other materials</b>	Lever: Stainless steel, polyamide (PA)
<b>Series</b>	C-TYPE	<b>Colour</b>	RAL 7040 grey
<b>Closing type</b>	With 2 levers	<b>RoHs conformity</b>	Compliant
<b>Size</b>	Size 77.27	<b>China RoHs - EFUP</b>	E
<b>Cable entry</b>	Top cable entry M25	<b>REACH SVHC substances</b>	No
<b>Specification</b>	Without gasket	<b>Approvals / Standards</b>	
<b>Technical data</b>		<b>Certifications</b>	DNV, BV
<b>IP degree of protection</b>	IP65 / IP66 / IP69	<b>UL</b>	ECBT2
<b>Further technical details</b>		<b>cUL</b>	ECBT8
<b>Weight</b>	212,00 g	<b>General ordering information</b>	
<b>Operating temperature range (min, max)</b>	-40°C...+125°C	<b>EAN13 code</b>	8015747055840
		<b>eCl@ss 8.1</b>	27440202
		<b>ETIM 7.0</b>	EC000437
		<b>Packaging Information</b>	
		<b>Packaging length</b>	300,00 mm
		<b>Packaging height</b>	160,00 mm
		<b>Packaging width</b>	180,00 mm
		<b>Packaging weight</b>	2,50 kg
		<b>Packaging volume</b>	8,64 dm <sup>3</sup>
		<b>Packaging description</b>	Carton box
		<b>Packaging quantity</b>	10 Pcs
		<b>Packaging EAN code</b>	8015747055857
		<b>Sub-packaging weight</b>	1,25 kg
		<b>Sub-packaging description</b>	Plastic packaging
		<b>Sub-packaging quantity</b>	5 Pcs
		<b>Sub-packaging EAN barcode</b>	8015747055864

Part number

# MHV 16 X25



Catalogue drawings

**CHO X (CAO X) - MHO X (MAO X)**

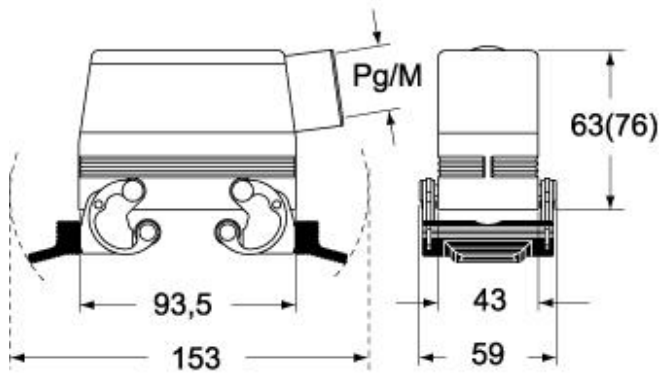

**CHV X (CAV X) - MHV X (MAV X)**



## Notes

Dimensions shown in mm are not binding and may be changed without notice.