

Part number

JCVP 10 LP



Surface mounting housing, JEI®-V series, with 1 lever, Pg16 cable entry, size "57.27", with plastic cover

Product description

Product type	Surface mounting housing
Series	JEI®-V
Closing type	With 1 lever
Size	Size 57.27
Cable entry	With cable entry Pg16
Specification	With plastic cover

Technical data

IP degree of protection	IP65
Further technical details	
Weight	276,00 g
Operating temperature range (min, max)	-40°C...+125°C

Material properties

Other materials	Lever: Galvanized steel Gasket: NBR
Colour	RAL 7040 grey

Approvals / Standards

Certifications	DNV, BV
UL	ECBT2
cUL	ECBT8

General ordering information

EAN13 code	8015747137744
-------------------	---------------

Packaging Information

Packaging length	370,00 mm
Packaging height	140,00 mm
Packaging width	210,00 mm
Packaging weight	3,01 kg
Packaging volume	10,88 dm ³
Packaging description	Carton box
Packaging quantity	10 Pcs
Packaging EAN code	8015747144124
Sub-packaging weight	1,51 kg
Sub-packaging description	Plastic packaging
Sub-packaging quantity	5 Pcs
Sub-packaging EAN barcode	8015747140416

Part number

JCVP 10 LP



Catalogue drawings

JCVP LP

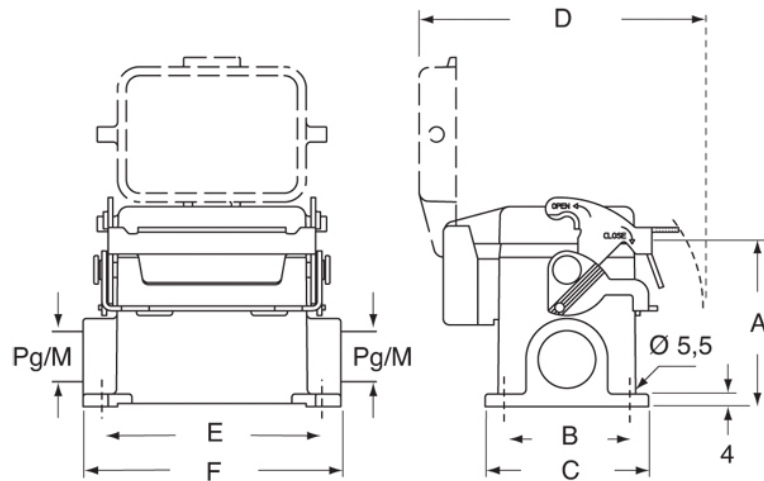

	A	B	C	D	E	F
JCVP 06 LP	53	40	52	91	70	82
JCVP 10 LP	57	40	52	94	82	93,5
JCVP 16 LP	63	45	57	94	105	117
JCVP 24 LP	63	45	57	94	132	144

Notes

Dimensions shown in mm are not binding and may be changed without notice.