

Part number

# C30FA 70



Female crimp contact, C30 series, 300 A, turned silver plated, wire cross section 70 mm<sup>2</sup>, AWG 2/0

Product description		Material properties	
<b>Product type</b>	Crimp contact	<b>Main material</b>	Copper alloy
<b>Series</b>	C30		Compliant with exemption 6(c): copper alloy containing up to 4% lead by weight
<b>Gender</b>	Female	<b>RoHs conformity</b>	
Technical data		<b>China RoHs - EFUP</b>	50
<b>Current</b>	300 A	<b>REACH SVHC substances</b>	Yes Lead
<b>Wire cross-section</b>	70,00 mm <sup>2</sup>	General ordering information	
<b>Contact type</b>	Turned silver plated	<b>EAN13 code</b>	8015747291125
Further technical details		Packaging Information	
<b>Contact resistance</b>	≤ 0,2 mΩ	<b>Packaging length</b>	112,00 mm
<b>Weight</b>	36,00 g	<b>Packaging height</b>	95,00 mm
<b>Conductors stripping length</b>	22,5 mm	<b>Packaging width</b>	117,00 mm
		<b>Packaging volume</b>	1,24 dm <sup>3</sup>
		<b>Packaging description</b>	Carton box
		<b>Packaging quantity</b>	40 Pcs
		<b>Packaging EAN code</b>	8015747291132
		<b>Sub-packaging description</b>	Plastic box
		<b>Sub-packaging quantity</b>	5 Pcs
		<b>Sub-packaging EAN barcode</b>	8015747291149

Part number

# C30FA 70



## Catalogue drawings

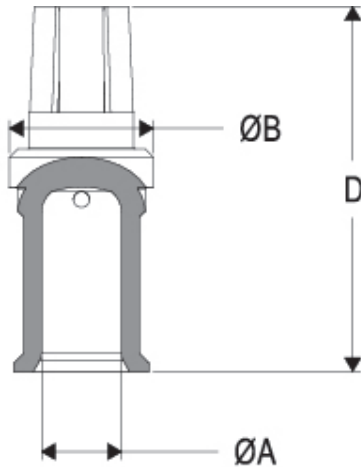

### C30FA contacts

conductor section (mm <sup>2</sup> )	conductor slot $\varnothing$ A (mm)	$\varnothing$ B (mm)	D (mm)	conductor stripping length (mm)
16	5,5	18	39,1	19
25	7	18	39,1	19
35	8,2	18	40,1	20
50	10	18	45,6	22,5
70	11,5	18	45,6	22,5
95	13,5	21	45,6	22,5
120	15,5	21	45,6	22,5

## Notes

### California Proposition 65 Information



### WARNING

This product can expose you to lead and its compounds, known to the State of California to cause cancer and/or reproductive toxicity. For more information go to [www.P65Warnings.ca.gov](http://www.P65Warnings.ca.gov).

Dimensions shown in mm are not binding and may be changed without notice.